

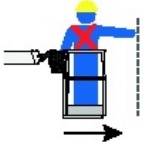

15,00 m



13,00 m



7,50 m

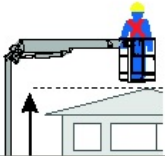

8,00 m

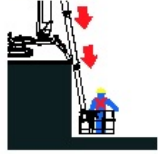

-1,50 m



200 kg

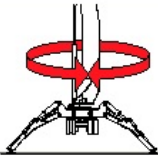

360°

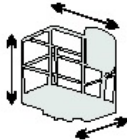

0,7X0,7X1,1
1,4X0,7X1,1

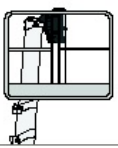

ALUMINIUM



ELECTRONIC
+ RADIO

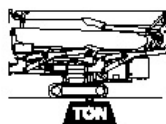

1,55 T

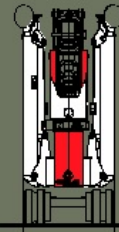
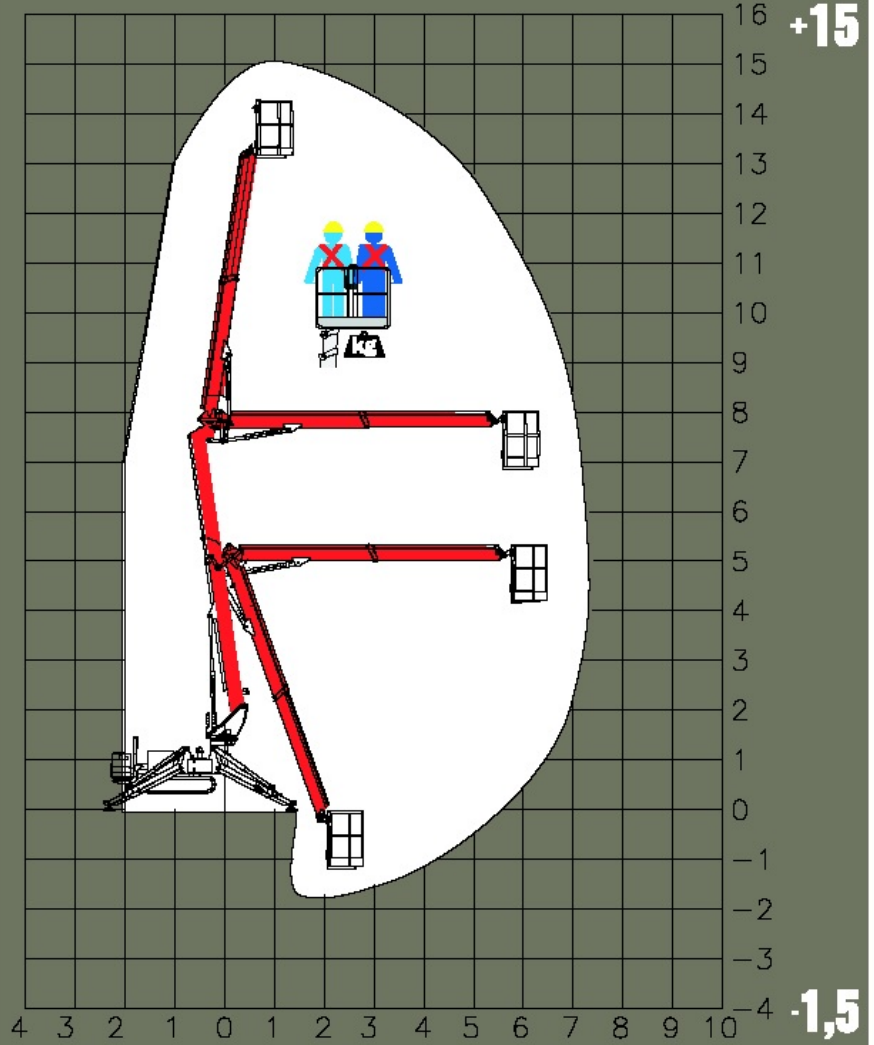

800

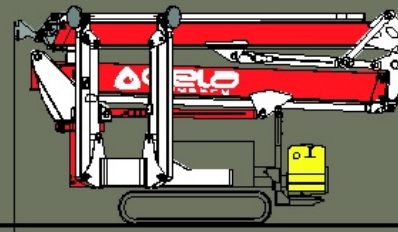

5950

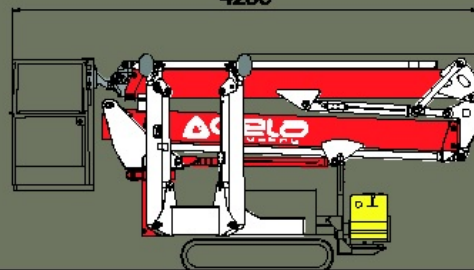

4250

1950

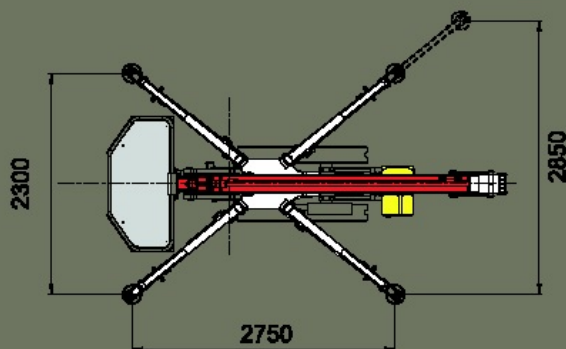

2300

2850

2750

DI 15
SPYDER